



sq16 & sq16plus Datalogger

sqhub Communications Gateway

SquirrelView Software

EN

Operating Manual

If you have any feedback on Grant's products or services, we would like to hear from you.
Contact:

Legal manufacturer

Grant Instruments (Cambridge) Ltd
Shepreth
Cambridgeshire
SG8 6GB
UK

Tel: +44 (0) 1763 260 811

E-mail: support@grantinstruments.com

Representative in the European Union

Grant Instruments Europe B.V
Strawinskylaan 411
WTC, Tower A, 4th Floor
1077 XX, Amsterdam
The Netherlands

E-mail: grant@eu.grantinstruments.com

Country of Origin: UK

Contents

1.0	Use of the products	5
2.0	How to use this operating manual.....	5
3.0	Safety information	5
3.1	Safety compliance.....	5
3.2	Safety symbols	5
3.3	Safety warnings	6
4.0	Operating instructions.....	7
4.1	Product description sq16, sq16 plus	7
4.1.1	Product Box contents	7
4.1.2	Connections	7
4.1.3	Controls and indicators.....	8
4.1.4	Digital I/O connections	9
4.2	Powering sq16 data loggers	10
4.3	Downloading and installing SquirrelView desktop software.....	11
4.4	Connecting to your logger using USB	13
4.5	Connecting to your logger using a mobile device.....	14
4.6	Using SquirrelView	15
4.6.1	SquirrelView Homepage.....	15
4.6.2	Logger Setup	16
4.6.3	Channel Setup	17
4.6.4	Editing Sample and Logging intervals	19
4.7	Logging Data	22
4.10	Download and Save Data	23
4.8	Format data	25
4.9	Exporting data from SquirrelView	27
4.9.1	Exporting Job Files.....	27
4.9.2	Exporting Datasets.....	27
5.0	sqhub	28
5.1	Product Description sqhub.....	28
5.1.1	Box contents	28
5.1.2	Front panel connections and indicators	28
5.2	Powering your sq hub Communications Gateway.....	29
5.3	Connecting to your logger across a network using a sqhub	29
5.3.1	Connect SquirrelView Desktop Software to your sqhub	29
5.3.2	Connecting sq 16 and sq 16 plus loggers to your sq hub	32
6.0	Technical specifications	34
6.1	Input ranges sq16.....	34
6.2	General specification sq16	35

6.3 General specification sq hub.....	36
7.0 Warranty Information.....	36
8.0 Maintenance and service	37
8.1 Cleaning	37
8.2 Replacing the mains PSU	37
8.3 Support and Service	37
9.0 Optional Accessories	38
10.0 Troubleshooting	38
11.0 Compliance	39

1.0 Use of the products

The following products are covered by this operating manual:

- sq16 datalogger
- sq16plus datalogger
- sqhub Communications Gateway

The product is a low-power data-logger designed for indoor use by, or supervised by, a professional user.

2.0 How to use this operating manual

This operating manual will allow you to unpack, set-up and operate this datalogger correctly and safely. Important safety information, symbols and warnings are listed below and should be read carefully before operating the product. Section 4 gives information about how to unpack and install the product correctly. Section 5 gives operating information for the equipment. Product technical specifications and tips are provided in sections 6 and 7. The warranty for this product is for THREE YEARS and should be registered by completing the on-line registration form which can be found at www.grantinstruments.com. Full details of warranty conditions can be found in section 8 of this manual

If you have any questions regarding the operation of the equipment, please contact your local distributor or Grant instruments who will be able to assist you with your enquiry.



3.0 Safety information

3.1 Safety compliance







The equipment meets the requirements of international safety standard IEC 61010-2-030: Safety requirements for electrical equipment for measurement, control, and laboratory use: Particular requirements for equipment having testing or measurement circuits.

3.2 Safety symbols

The symbols below are marked on the equipment and throughout this manual to indicate:

	Read these instructions before installation or use of the datalogger
	Warning, hazard: read these instructions before proceeding to ensure you understand the nature of the hazard.

3.3 Safety warnings

	Use only as specified by the operating instructions: if the equipment is used in a manner not specified by the manufacturer, the protection provided by the equipment may be impaired.
	Do not connect the logger to hazardous voltages:- because it is floating with respect to earth, the hazardous voltage can appear on other terminals (as well as damaging the logger).
	The insulation of the wiring used to connect to the sensor inputs must be adequate for the voltages to be measured. This means for example that at least 75V rated insulation is required if using the -25V to +50V range (sq16) and that at least 100V rated insulation is required if using the -40V to +60V range (sq16plus).
	The logger is designed to be powered by a class II power supply (no Earth connection) for maximum flexibility.
	Remove the batteries when the logger is not used for long periods of time or is being transported
	This logger is not designed for safety critical applications: do not rely on it to verify safe conditions before carrying out any potentially hazardous activities.

4.0 Operating instructions

4.1 Product description sq16, sq16 plus

The product is a low-power data-logger designed for indoor use by, or supervised by, a professional user.

4.1.1 Product Box contents

- sq16 or sq16 plus Datalogger
- Mains Adapter MPU 12V
- USB cable
- AA Batteries x 6
- Current shunt resistors for 4 to 20mA inputs, 10ohms x 4
- Sensor Connectors, 6-way x 4, 3-way x1 with cable ties
- Getting Started Guide (this booklet)
- Warranty Card

Unpack the contents, check everything is present and retain the outer packaging for future use.

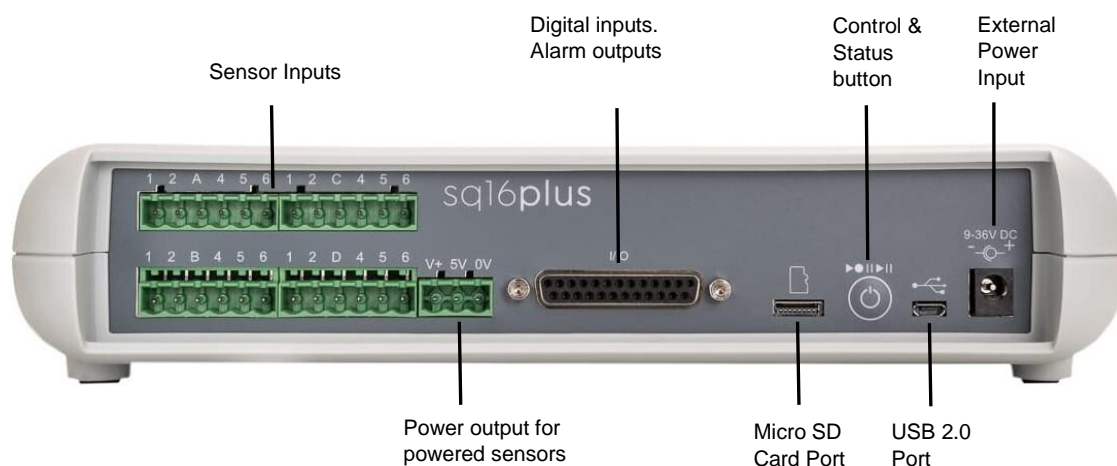











4.1.2 Connections

1. Floating connections			
Connection	Description	Maximum permissible ratings	
<i>Sensor Inputs</i> sq16	Inputs for measuring voltage, current and temperature	Common-mode voltage w.r.t. supply 0V	+/- 60Vdc
		Voltage between pins	75Vdc
<i>Sensor Inputs</i> sq16plus	Inputs for measuring voltage, current and temperature	Common-mode voltage w.r.t. supply 0V	+/- 60Vdc
		Voltage between pins	100Vdc

2. Connections referenced to 0V of External Power Input		
Connection	Description	Maximum permissible ratings
<i>Power output for powered sensors "5V"</i>	5V output. 0V is common with External Power Input	50mA
<i>Power output for powered sensors "V+"</i>	Tracks <i>External Power Input</i> (9-36Vdc)	100mA
<i>Digital inputs</i>	<i>Zero</i> input voltage	0 to 0.5V (or shorted input)
	<i>One</i> input voltage	2.7 to 5V (or open circuit input)
<i>Alarm outputs</i>	4 x open drain FET	36V 0.1A Max
<i>Micro SD Card Port</i>	Optional Micro SD Card	16Gb minimum Micro SD Card
<i>External Power Input</i>	Input for Class II (double insulated) power-supply	9-36Vdc, 1.1A
<i>USB 2.0 Port</i>	USB 2.0 compliant serial interface	

4.1.3 Controls and indicators

Action	Control & Status button colour	What this means
Momentarily press button	 Alternate for 3 seconds	Logger is idle (not logging or armed or waiting for a trigger)
Momentarily press button	 Flash for 3 seconds	Logger is logging
Momentarily press button	 Flash for 3 seconds	Indicates alarm(s) triggered
Momentarily press button	 Continuous for 3 seconds	Indicates a logger fault
Momentarily press button	 Alternate for 3 seconds	Logger is programmed, armed and ready to log waiting for a trigger or has a delayed start
When idle press and hold button until it flashes green rapidly (about 2 seconds) and then release	 Flash for 3 seconds	Start Logging
When logging press and hold button until it flashes green rapidly (about 3 seconds) and then release	 Alternate for 3 seconds	Stop Logging
Press button all through the rapid green flashing described above until it flashes blue rapidly (about 5 seconds) and then release	 Flashing after button held for 5s  Bluetooth ON, flash every 10s  Bluetooth is OFF, no blue flash	Turns Bluetooth ON if OFF or OFF if already ON.

4.1.4 Digital I/O connections

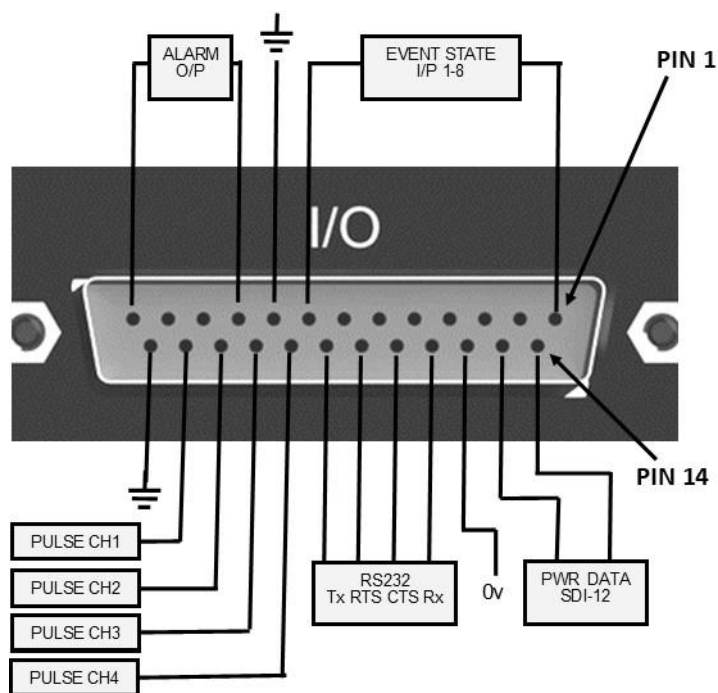

Pin	Connection	Pin	Connection
1	Event/State Input 1	14	SDI-12 Power
2	Event/State Input 2	15	SDI-12 Data
3	Event/State Input 3	16	Comms 0V
4	Event/State Input 4	17	RS232 Rx
5	Event/State Input 5	18	RS232 RTS
6	Event/State Input 6	19	RS232 CTS
7	Event/State Input 7	20	RS232 TX
8	Event/State Input 8	21	Fast Pulse Input 1 – Pulse Channel #87
9	Ground	22	Fast Pulse Input 2 – Pulse Channel #86
10	Alarm Output A	23	Slow Pulse Input 1 – Pulse Channel #85
11	Alarm Output B	24	Slow Pulse Input 2 – Pulse Channel #84
13	Alarm Output C	25	Ground
13	Alarm Output D		

4.2 Powering sq16 data loggers

Fit the AA Manganese alkaline batteries when remote or mobile operation is required and to ensure logged data protection in the event of unexpected mains power loss. The battery compartment is at the rear of the logger, observe battery polarity.

When batteries are first fitted, and they are the only power source, then press and hold the Control & Status button until the lights up and then release to power up the logger.



It is recommended that replacement batteries are of the same manufacturer, type, and condition.

Power can be provided by a USB connection from a powered USB socket in a PC or Laptop.

For continuous use where mains power is available, plug the MPU 12V mains adapter into an accessible mains outlet. Insert the Jack plug into the sq16 External power input.

Only use the mains adapter supplied by Grant Instruments for the external power source

Always power your sq16 logger using the mains adapter if external sensors powered by the logger are being used.

	The logger is designed to be powered by a class II power supply (no Earth connection) for maximum flexibility.
	Remove the batteries when the logger is not used for long periods of time or is being transported

4.3 Downloading and installing SquirrelView desktop software

Minimum PC requirements: Windows 10.

Ensure you have administrative rights for the PC on which to install the software

Please follow the steps below

1. Follow this link or copy the URL into your browser
<https://www.grantinstruments.com/our-products/software/squirrelviewsoftware> or scan the QR code.



2. From the webpage Software Download area, download the SquirrelViewinstaller.zip file and open the folder to view the contents
3. Save a copy of the Licence certBasic.pem file in your PC Download folder.
4. If you have purchased the SQS200 or professional software upgrade, register online to receive the upgraded licence. This is available on the same SquirrelView Software web page or directly from this link <https://www.grantinstruments.com/request-professional-software> or this QR code

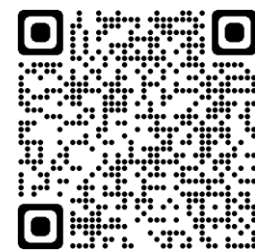

5. The Licence file will be sent to your registered email address. Save a copy of the Licence certPro.pem file in your PC Download folder.
6. Run SquirrelView_Installer.exe program to start the installation

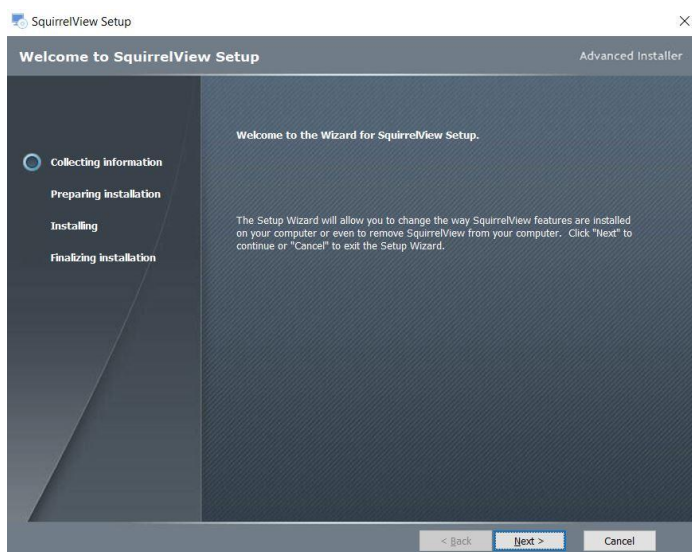

7. Follow the on-screen installation wizard. Click on Finish to complete the installation
8. Start SquirrelView
9. When prompted, click on the **Import Key** button.

Select the certBasic.pem or certPro.pem (if available) file from the Download folder and click **Open**.

To upgrade from the Basic to Professional Licence at a later stage, click on the **About** button in SquirrelView followed by the **Import New Licence** button.

SquirrelView is now ready to use

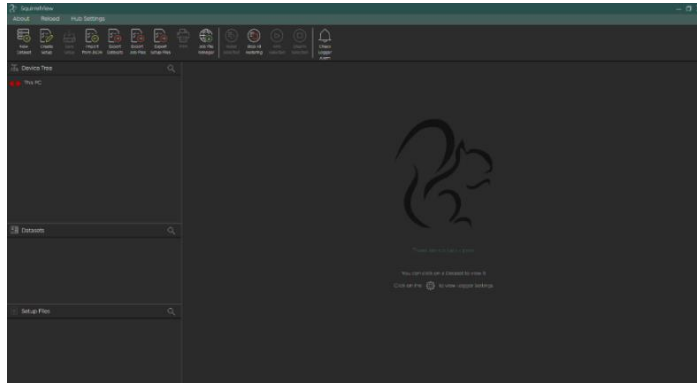

4.4 Connecting to your logger using USB

Important: please ensure the software is installed before connecting your logger
Connect your sq16 logger to the PC using the USB lead supplied.

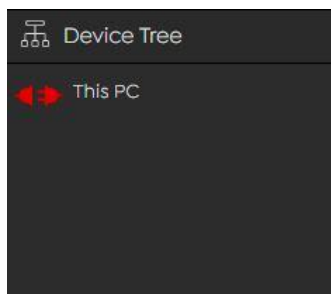

Start SquirrelView Desktop.

Click on the Plug icon  to connect to the logger.

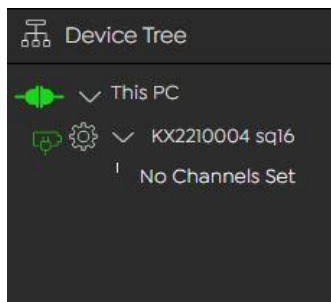

The Plug icon will change to Connected  and the logger will appear in the Device Tree with the logger serial number followed by the logger model sq16 or sq16plus for example KX2120113 sq16.

Click on the Logger Settings icon  to configure your logger with sensor inputs and other logging configuration details.

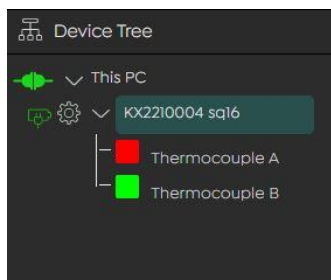

Once configured, click on the logger's name to select and enable logging and metering of sensor data.



Scan to find further help and resources on how to use your sq16 logger and SquirrelView Desktop Software

4.5 Connecting to your logger using a mobile device

You can communicate with your sq16 logger directly on any Android, iPad or iPhone device using Bluetooth or through a sqhub using Wi-Fi.

Download the SquirrelView App from your App Store and install on your mobile device. Scan the QR codes below to get started.



Google Play App Store for Android

Apple App Store for iOS

Ensure your logger is powered up with the Bluetooth turned on (see section 2)
Open the SquirrelView App and select the Bluetooth icon

The App will find all available Grant loggers within range using Bluetooth or Wi-Fi (if using a sqhub).

Your logger can be identified by its serial number, for example KX2120113 or it's Logger Identification name if it has been configured.

Tap on the Logger item in the list to setup the sensor inputs, meter real time data and configure other logger settings.

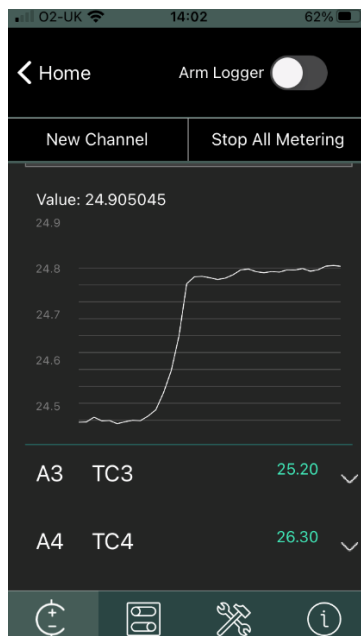
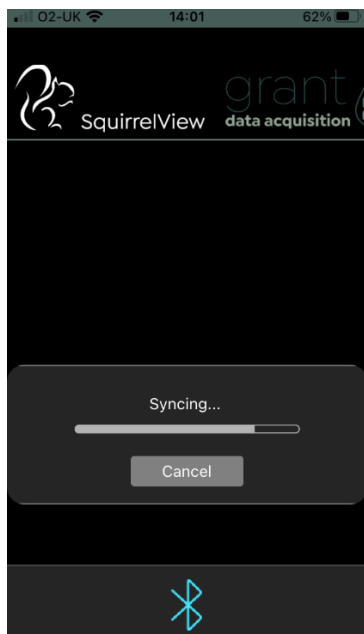

Scan to find further help and resources on how to use your sq16 logger and SquirrelView App

4.6 Using SquirrelView

4.6.1 SquirrelView Homepage

The SquirrelView Desktop homepage is the main interface for connecting and managing Squirrel data loggers and data.

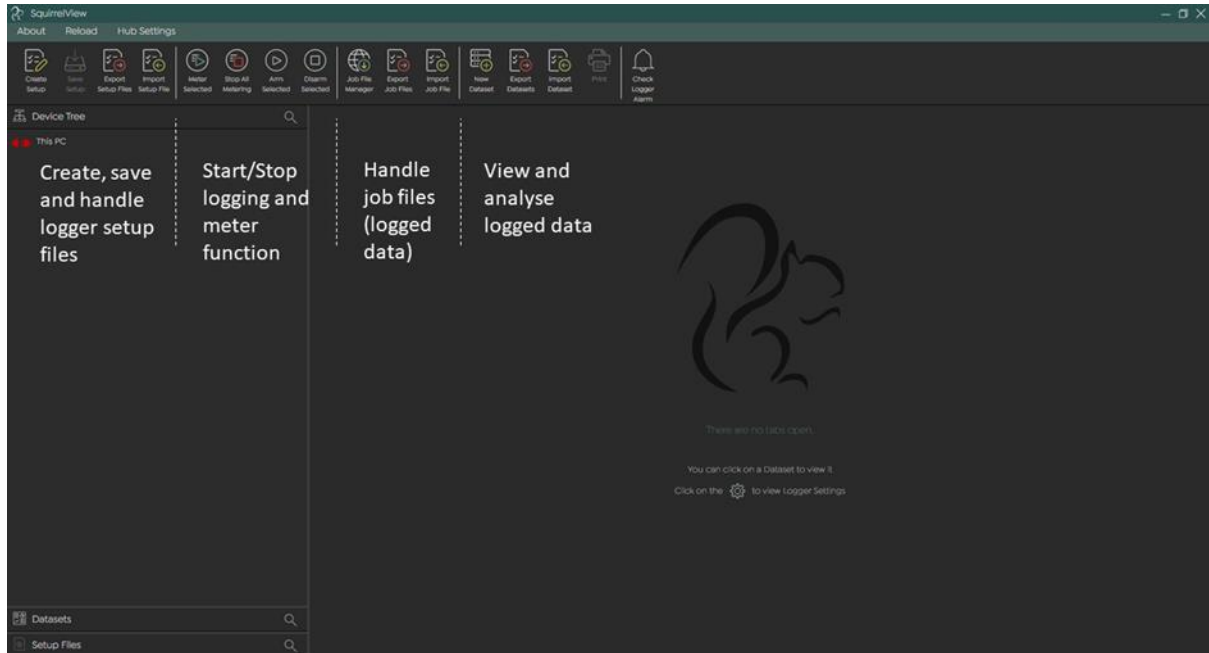

The top of the homepage has details regarding the software version, the possibility to reload and refresh the software and gain access to the hub settings if connected.

Below this is the main ribbon which is arranged in 4 main sections. These handle set up, actions during logging, handling job files and data sets as well as the option to check logger alarm status.

Below the main ribbon and to the left side are three areas which can be expanded or collapsed by clicking on them; the Device Tree, Datasets and Setup Files.

Under the device tree is the connection icon . When connecting a logger with a USB cable, click this icon to make a connection and use the software.

Note, when you hover your mouse over any of the clickable items in the software, the object or icon will indicate they can be clicked allowing access to sub-menus.

4.6.2 Logger Setup

To get your sq16, sq16plus or sq16pro data logger set up and ready for data logging, open SquirrelView Software and connect logger using the USB cable.

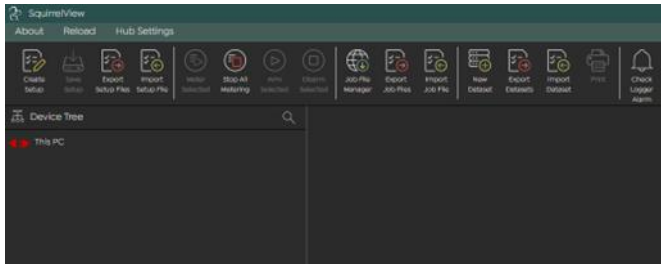

Click on the Connection under Device Tree 

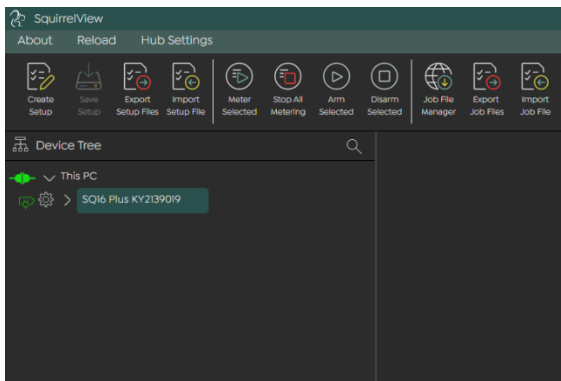

The Logger is now connected. The software will detect what type of logger it is and display the type and serial number. For a full list of data logger products this software will support refer to the specification table.

To configure the logger, click on the  icon associated to the logger to open the logger settings:

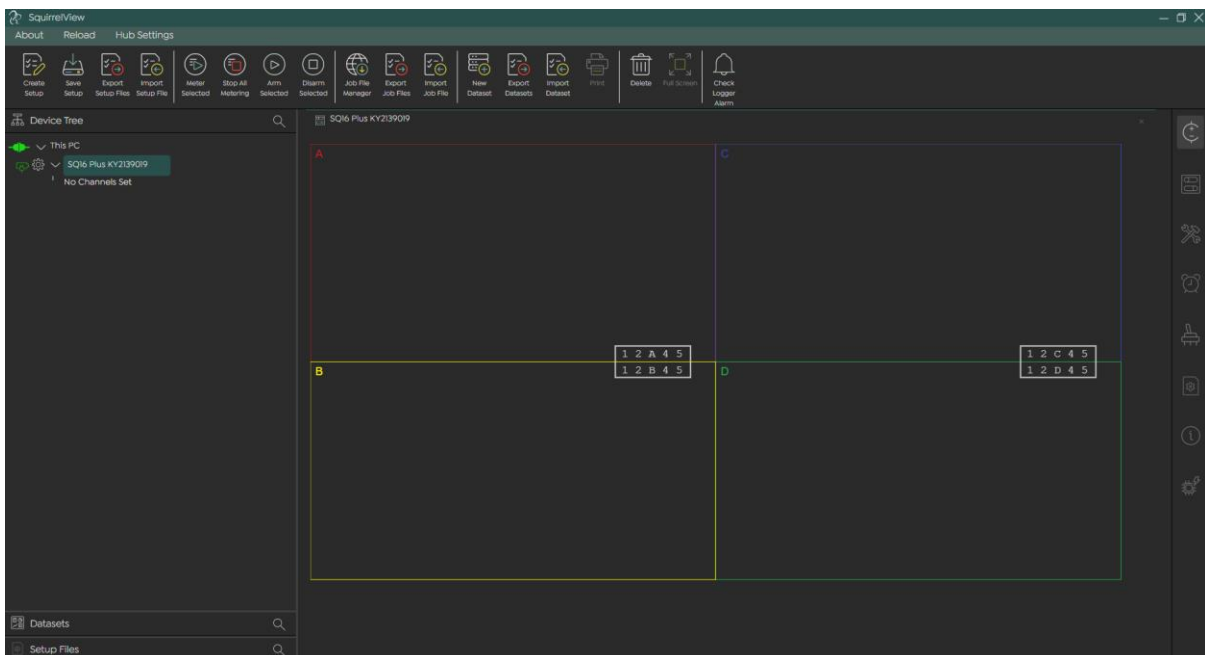

4.6.3 Channel Setup

On the right side of the display, click on the Channel Configuration tab  to add or edit channels

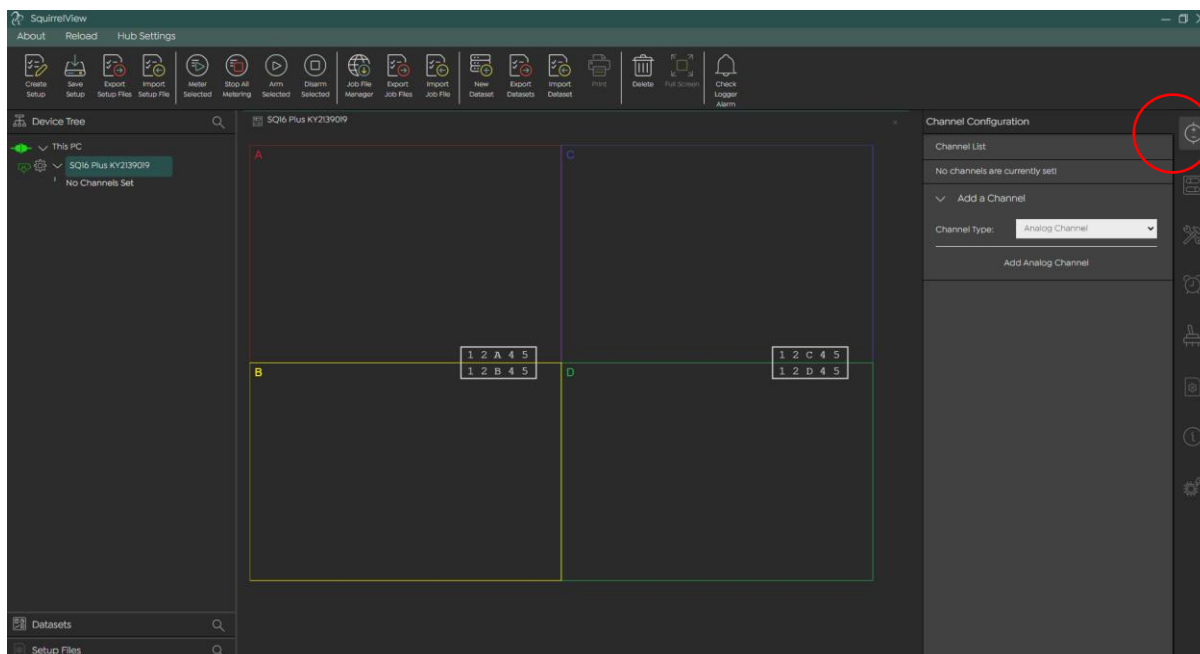

Note, the above schematic refers to the input pins in each of the four blocks of the logger:

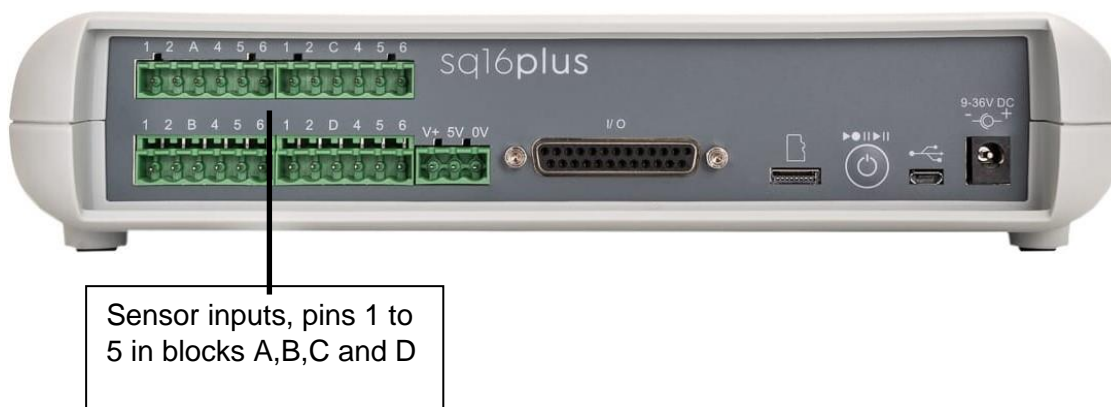

There are 5 different types of channels that may be measured and recorded by the sq16, and sq16plus loggers, these are:

Analog – for Resistance, Voltage, Current, Temperature (Thermistor, Thermocouple, PTD)

Calculated – Log mathematical calculations on measured channels

Pulse – Pulse count and pulse rate measurements

Event – Monitor and record the digital inputs as a number (0-255) or state (8 bit)

Reference Junction – Log the internal thermocouple reference junction temperature

To add an Analog channel, click on the channel configuration icon and select the appropriate sensor/probe type from the drop down menu:

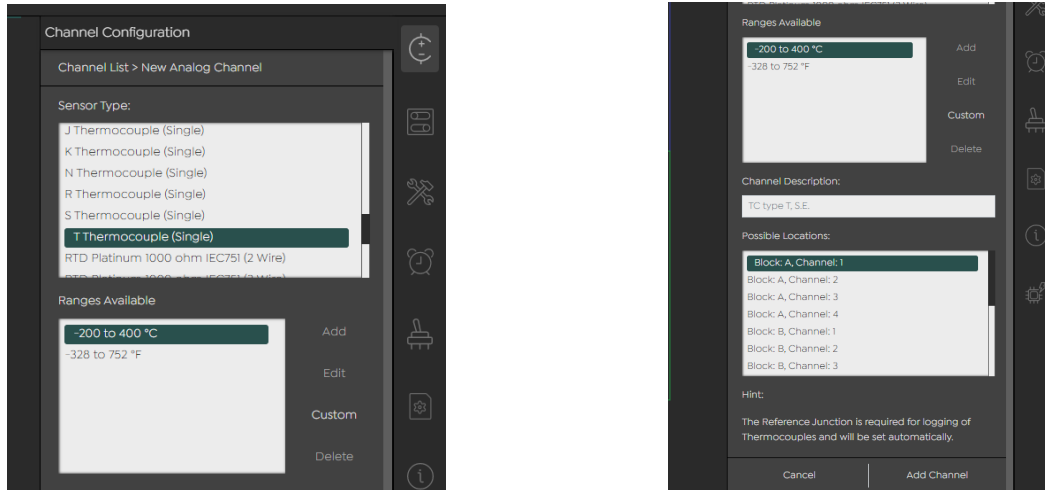

Select location in the example, Block A, Channel 1 is the default, click Add Channel.

The software will show the probe input positions corresponding to the logger input pins:

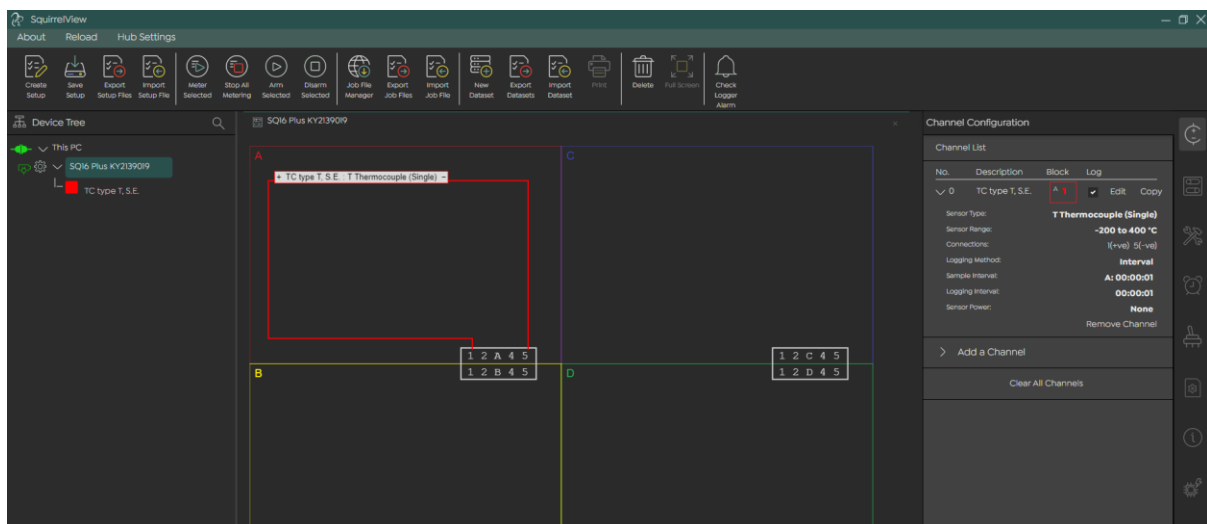

Repeat for other probes. Hint, use the copy function if the probes are the same type:

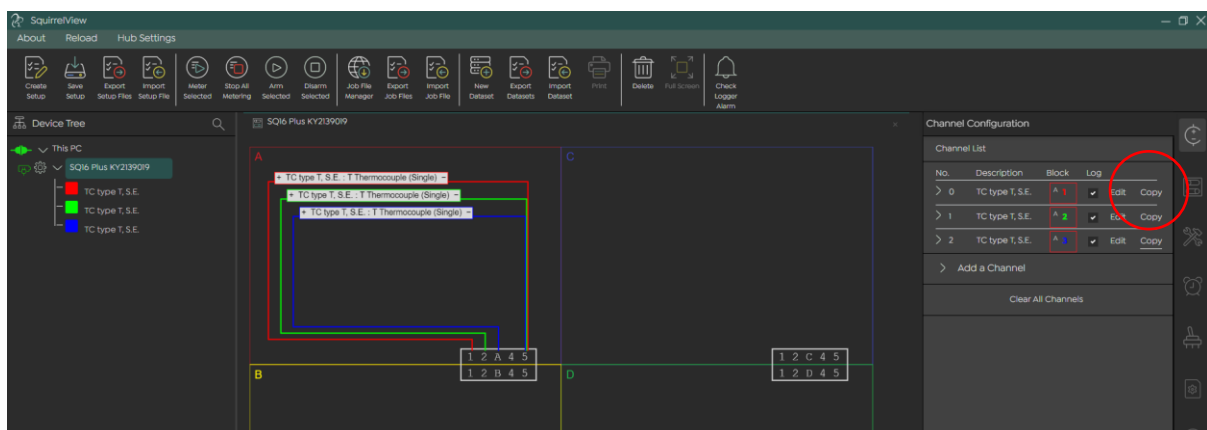

In the example below, 12 type T thermocouples are configured in single ended mode.

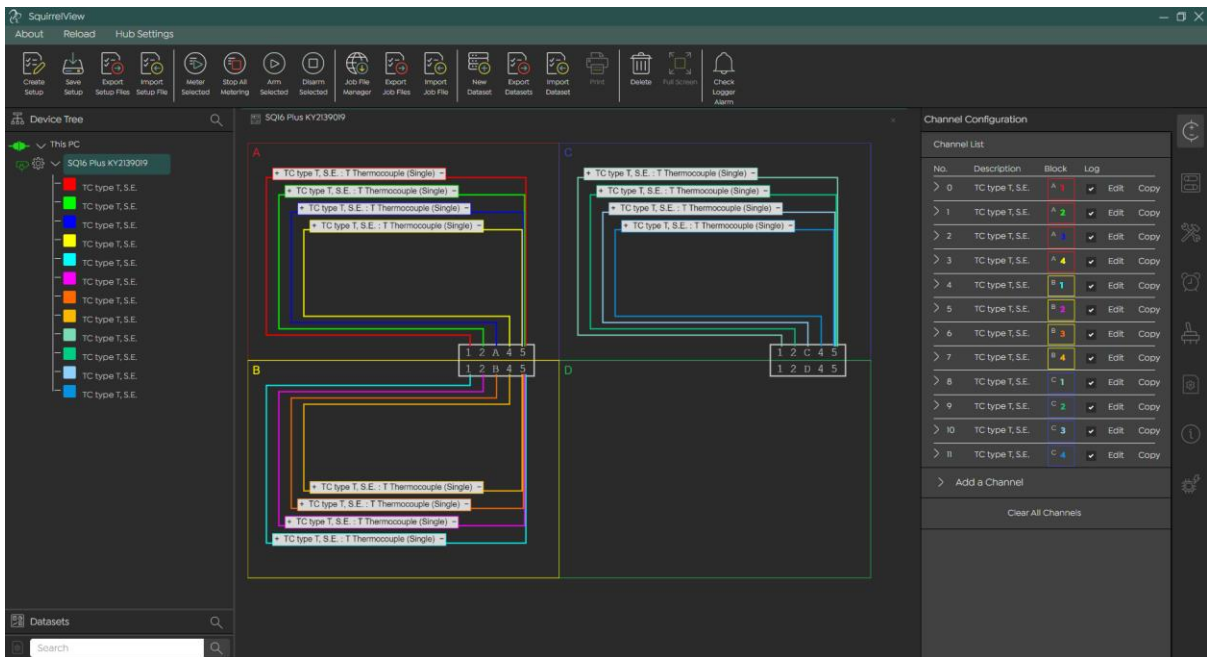

Note, the software will always offer the next available channel for the selected probe type by default.

4.6.4 Editing Sample and Logging intervals

The Default logging method is Interval and default Sample and Logging Intervals are 1 per second. These may be changed by clicking on the > which opens the Logging Method menu:

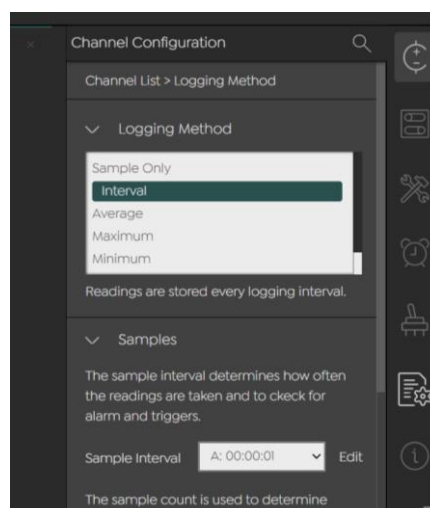
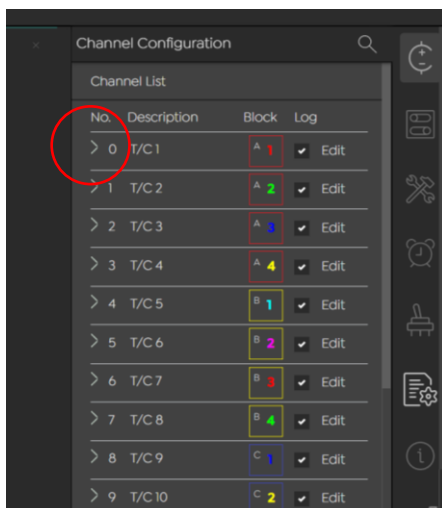

Clicking on the > opens the Logging Method menu.

Logging Method

This specifies how the readings taken for a channel are logged to memory, there are following different logging options:

Interval

Readings are stored at every Logging Interval. This is the default setting.

Average

Readings are taken at every Sample Interval and the average of these are stored at every Logging Interval.

Minimum & Maximum

Readings are taken at every sample interval and the maximum or minimum of these are stored at every Logging Interval.

Sum

Readings are taken at every sample interval and the sum is stored at every Logging Interval.

Sample Only

Readings are not logged

Note on **Sample Interval**, **Sample Count** and **Logging Interval**

The sample interval default is 1 second, this means all channels are monitored every second. Readings are not necessarily logged and stored every second, as the Logging Interval determines this. To increase the time between logged readings, edit the Sample Count whilst leaving the Sample Interval at 1 per second. For example, in the following with a Sample Interval at 1 second and a sample count set at 60 the logger will save readings to memory every 60 seconds:

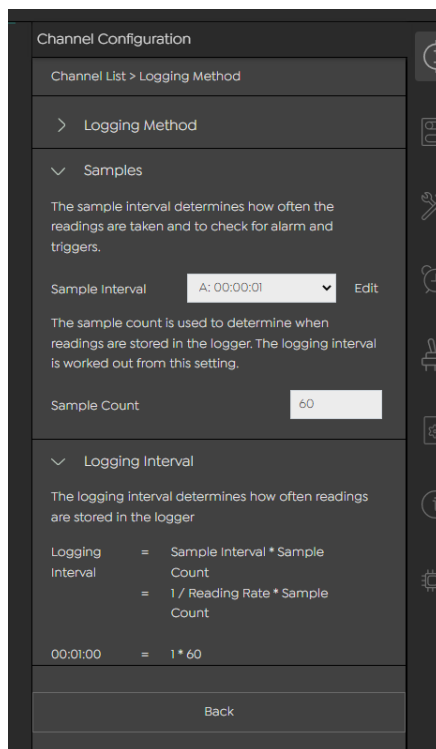

The Setup is created and exists in the data logger, a copy of the Setup may be saved to the desktop software. To save the Setup click on Save Setup:

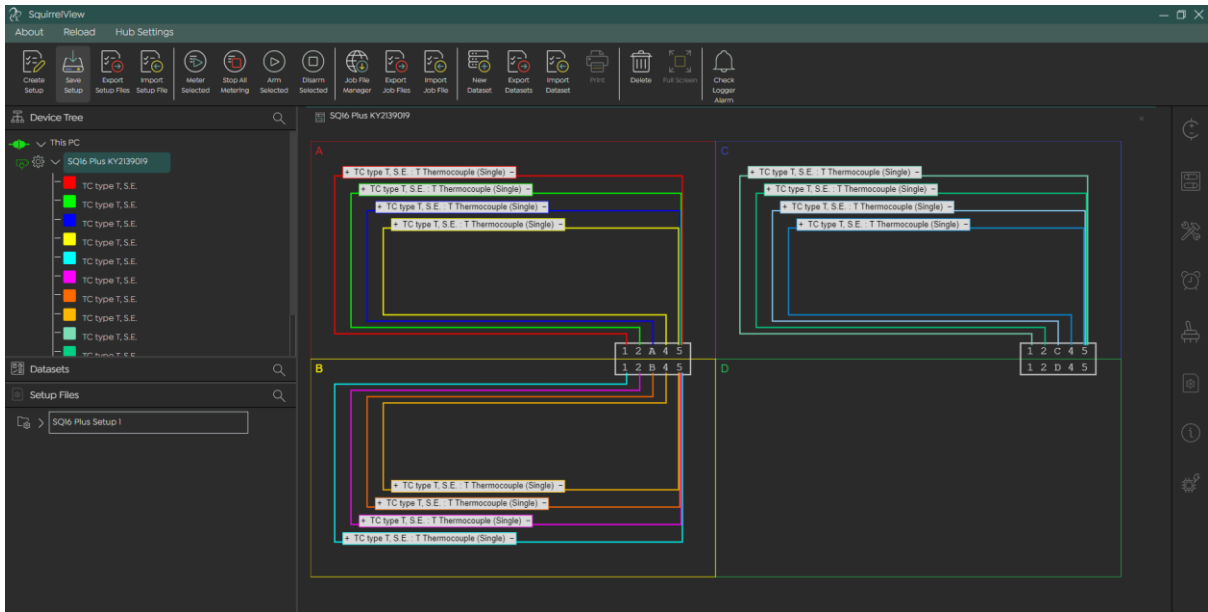

A copy of the setup file is saved in the desktop. The name and details of the file may be edited.

Setup files may be exported, so that they are saved outside SquirrelView software for example, and emailed or copied to another user.



Clicking on **Export Setup Files** allows this:

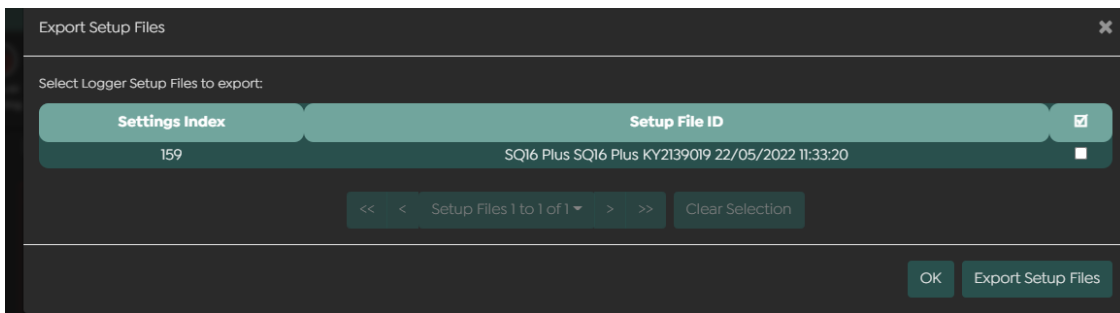

Tick the appropriate Setup File and click on Export Setup Files, this will allow files will be saved locally as JSON files.

4.7 Logging Data



With the probe connections made to the logger, highlight and click on Arm Selected

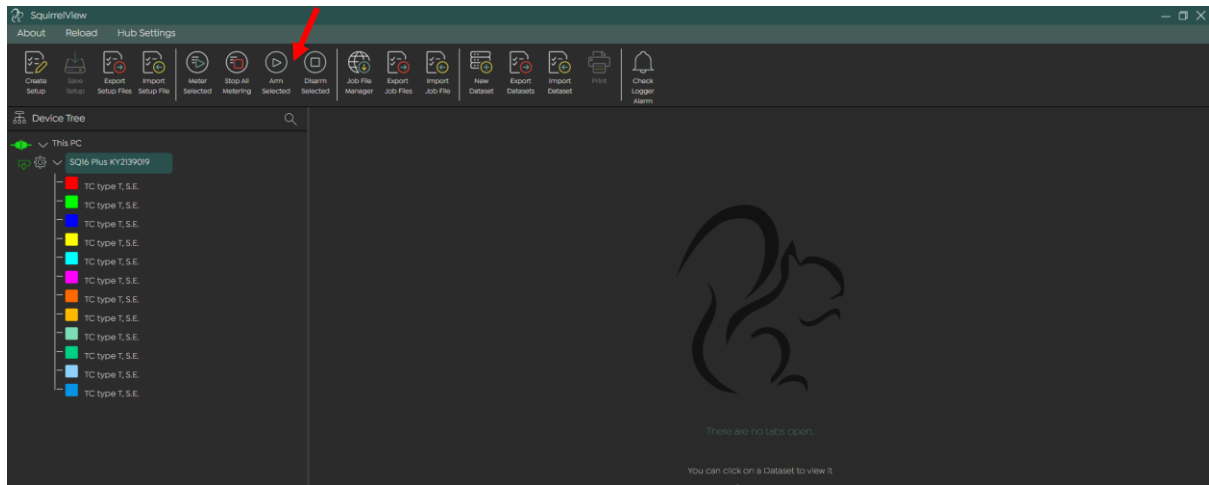

The notification 'Logging' will appear next to the logger

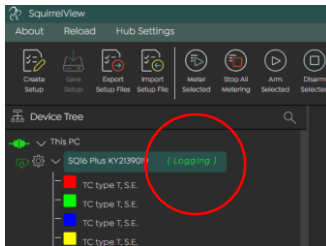

Should you wish to meter the data, that is view the readings in real time, click on Meter Selected

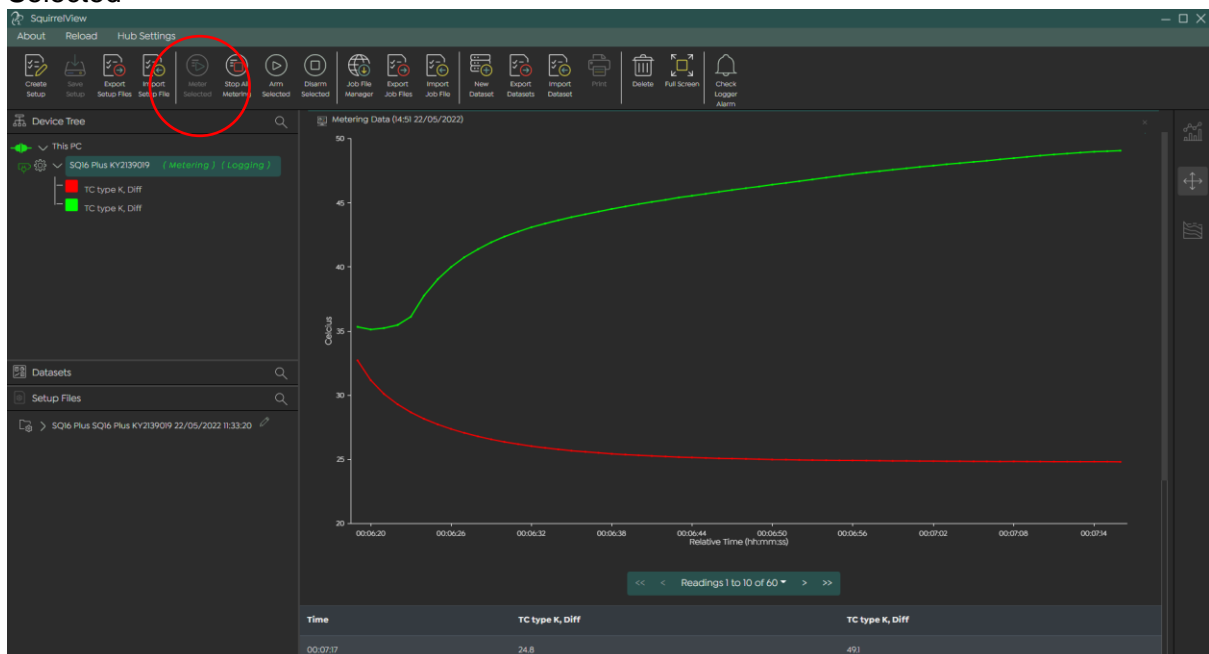

Meter mode allows you to view data from all measurement channels at a frequency of 1 reading per second in real time.

Note: when correct measurements are important, use the metering function to verify the credibility of measured values before relying on the logger to collect the values.

4.10 Download and Save Data

When a log is complete, then the logging process may be stopped by clicking on Disarm Selected.

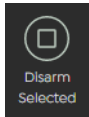

At this point a Job File with the measured data is created in the data logger memory. This data can be saved as a Dataset. To do this click on Job File Manager:

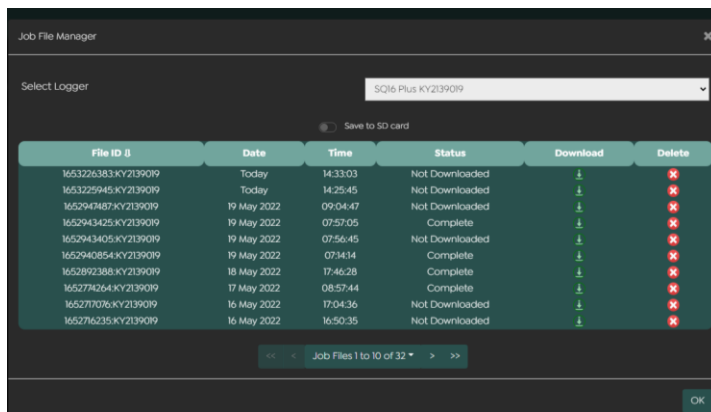
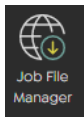

The files in the data logger with their download status are displayed by time and date.

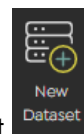
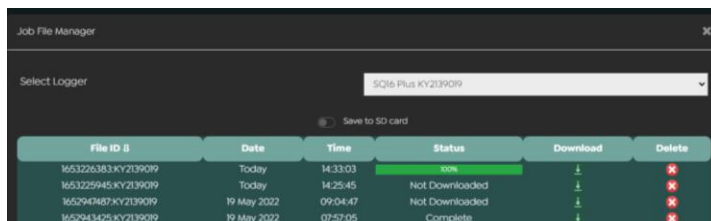

Once downloaded the data can be viewed in a Dataset, click on New Dataset

This opens the New Dataset menu, select and tick the relevant File then click Create Dataset

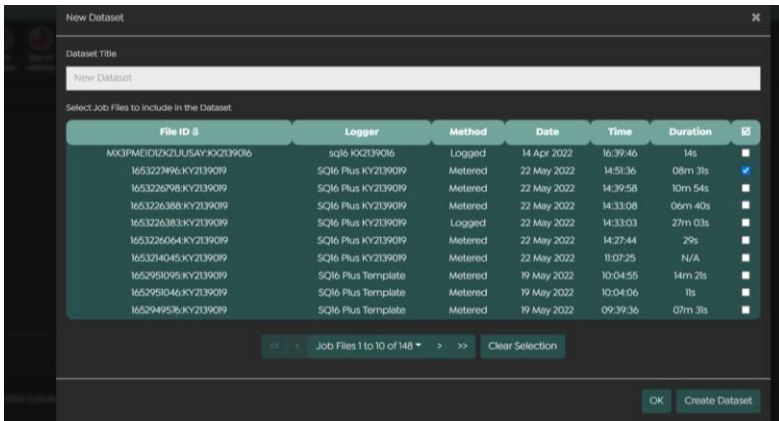

The newly created dataset will appear in the Dataset library:



4.8 Format data

Open a Dataset and view data. Note, select Absolute Time (actual time of readings) or Relative Time (from start of logging) to display data. Select Absolute Time to display the time and date of the measured readings.



Options for changing the graph display and formatting the data are available through the menu tabs on the right side of the display. Here you can edit the graph type, change the title of the graph, alter the x and y axis and add threshold limit values:



Use the cursor to highlight an area of the data and zoom in on it:

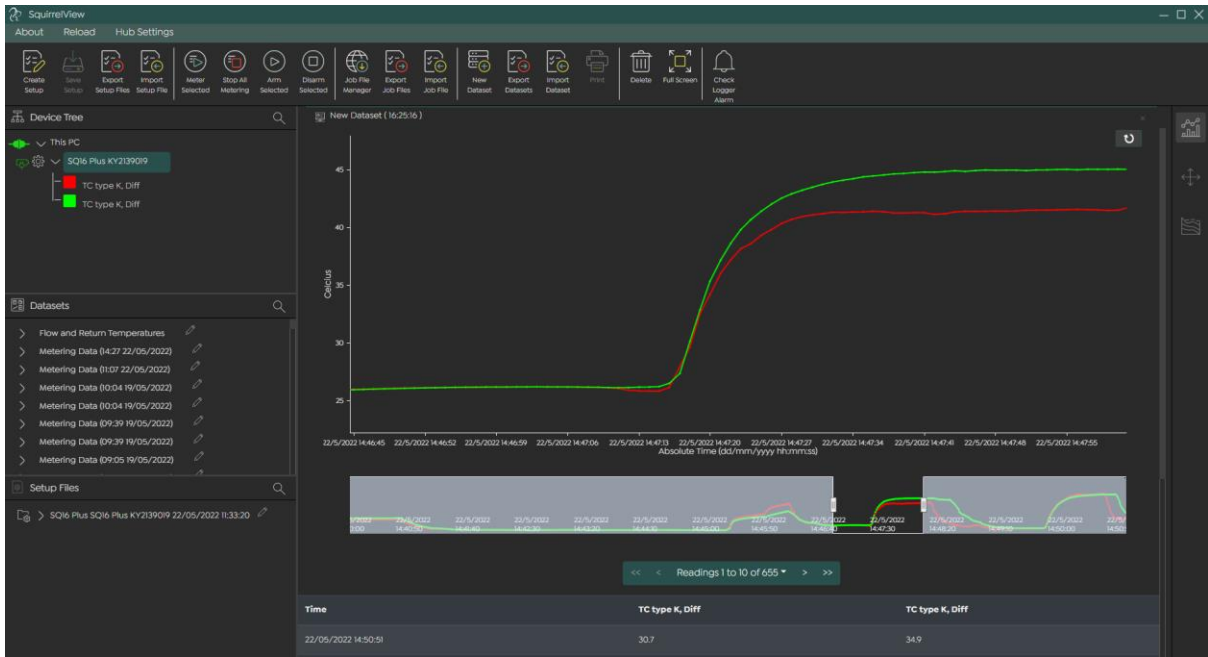

4.9 Exporting data from SquirrelView

4.9.1 Exporting Job Files

SQV has the option to export Job Files in either Microsoft Excel XLSX or CSV formats (in the CSV export the delimiter can be set as Comma, Dot, Tab, Space or Custom).

Job Files can be exported in JSON format, these files can be reimported to SQV later.

4.9.2 Exporting Datasets

Complete Datasets can be exported in JSON format; these files can be reimported and viewed in SQV later.

SQV has the option to export* Datasets in either XLSX or CSV formats (in the CSV export the delimiter can be set as Comma, Dot, Tab, Space or Custom).

ODS and HTML exporting* of Datasets is also supported.

*Note, when exporting these datasets in SQV if channels are switch off or the time window is altered only the data visible on the graph and data tables are exported to file.

Setting Excel to switch decimal separator to comma.

SQV will always use the dot/full stop "." as the decimal point. To import SQV data files into Excel with the dot/full stop replaced by a comma Follow the steps below.

To set the decimal separator, click on File > Options. In the Options window, click on "Advanced".

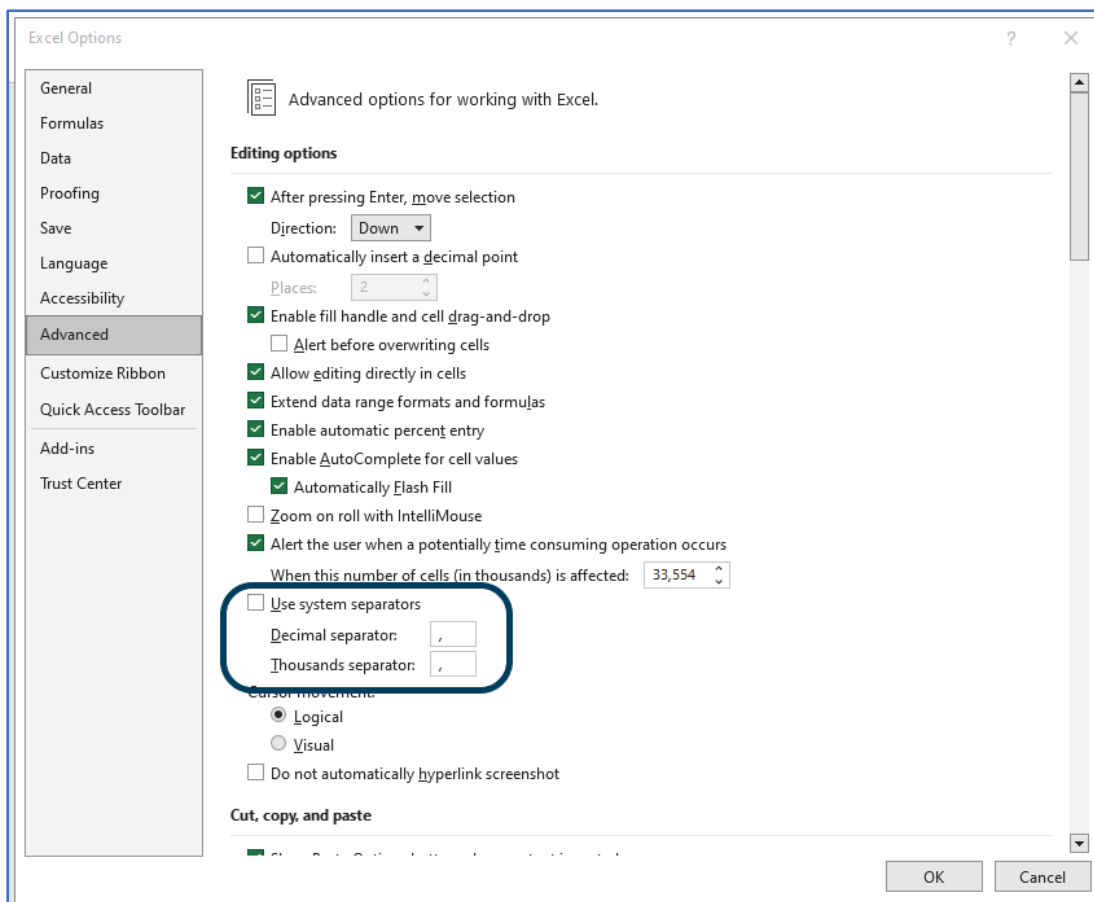

If the "Use system separators" box is checked, Excel will use whatever decimal separator is specified in Windows regional settings. For example, if your location is the United States, the default is decimal point. If your location is Germany, the default is decimal comma.

To override the system setting, uncheck "Use system separators" and enter the decimal separator in the box. If your system setting uses decimal point, and the override is decimal comma, then numbers will appear in Excel cells using comma as the decimal.

5.0 sqhub

5.1 Product Description sqhub

The product is a low-power data communications gateway designed for indoor use by, or supervised by, a professional user.



5.1.1 Box contents



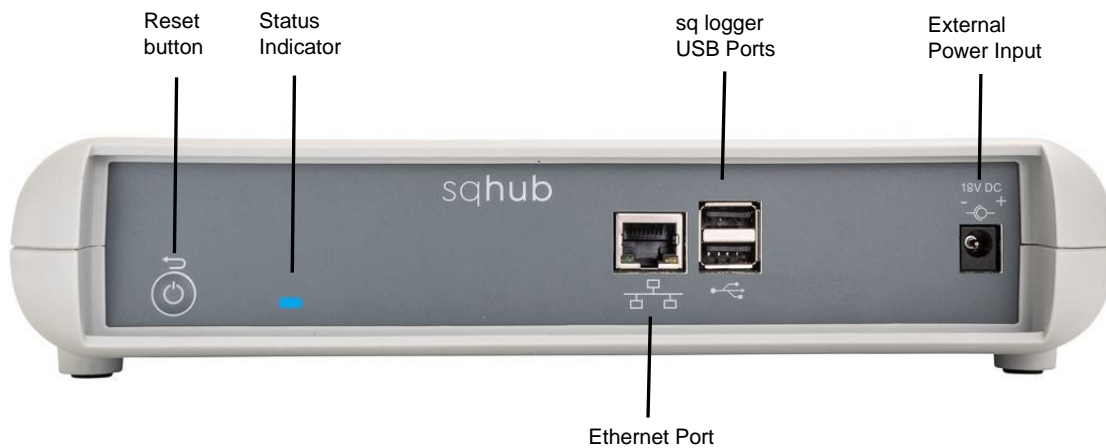

- sq hub Communications Gateway
- Mains Adapter MPU 18V
- Getting Started Guide (this booklet)
- Warranty Card

Unpack the contents, check everything is present and retain the outer packaging for future use.

5.1.2 Front panel connections and indicators



Status Indicator colour	What this means
 Blue Amber Green	Power ON sequence
 Amber Red Blue	Power OFF sequence

	Repeated Amber Flashing	Busy, please wait
	Green double Flash every 3 seconds	Wi-Fi Access Point Mode
	Green single Flash every 3seconds	Wi-Fi Network connected
	Red single Flash every 3 seconds	Unable to connect to Wi-Fi Network

Reset button function	Action	Status Indicator colour
Reset Wi-Fi to Network Access mode	Press and hold button (LED immediately goes blue), wait for LED to go green then release	

5.2 Powering your sq hub Communications Gateway

Plug the MPU 12V mains adapter into an accessible mains outlet. Only use the mains adapter supplied by Grant Instruments for the external power source.

Insert the Jack plug into the sq16 External Power Input.

The sq hub will power on immediately. There is power on sequence. The sq hub is ready to used when the LED Indicator is no longer Amber.

To power off your sqhub at any time, switch off the mains at the outlet or remove the Jack Plug.

The sq hub has a power off sequence. Do not plug the Jack Plug back in whilst the LED indicator is Red.

Your sq hub can provide power for up to two sq16 or sq16 plus loggers. Additional loggers can be powered using a mains powered USB2 Hub (not supplied)

5.3 Connecting to your logger across a network using a sqhub

5.3.1 Connect SquirrelView Desktop Software to your sqhub

Ensure SquirrelView Desktop Software is installed and started and your sqhub is powered on.

Connect the sqhub to the same Ethernet Local Area Network as the PC using a network cable or W-Fi.

Using a network cable:

Connect an Ethernet cable directly between the sqhub Ethernet port and an available port on your local area network. In SquirrelView the sqhub will be automatically discovered in the Device tree and is identified by the unit Serial Number e.g. KW228007

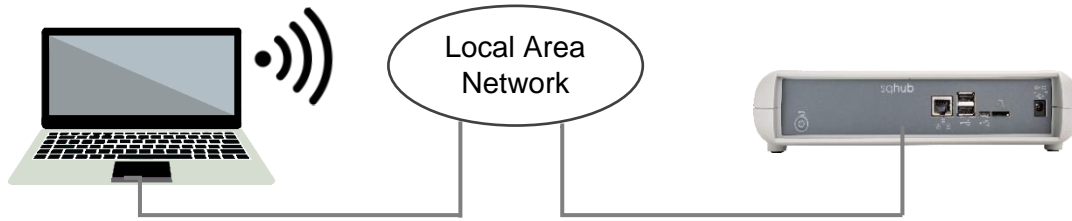

Using Wi-Fi:

Ensure the sqhub is in Network Access mode, the indicator LED will double flash Green.

If not, press and hold the reset button (LED immediately goes blue), wait for LED to go green then release.

On your PC, bring up a list of available Wi-Fi networks.

The sqhub will be available as a network shown as sqhub followed by the serial number e.g. sqhub-KW2220007

Disconnect the PC Wi-Fi from your Local Area network and connect directly to the sqhub.



The sqhub Wi-Fi network security password is 'granthub'

In SquirrelView, your new sqhub will appear in the Device Tree. Note that any existing sqhubs on a Wi-Fi network will disconnect whilst this setup is in progress.

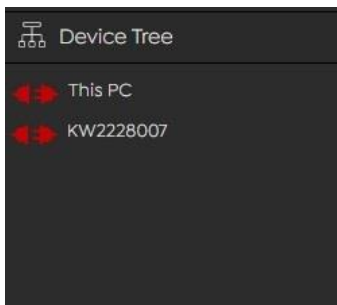

Your sqhub can be identified the Device tree by its Serial number. In this example KW228007

Click on the Plug icon of the sqhub  to connect.



On the SquirrelView mainscreen, click on **Hub Settings**.

Your new sqhub will be available in the drop down list.

Select your chosen Wi-Fi Network from the list of available networks

Reconnect your PC to your chosen Wi-Fi network



Your sqhub will now be available again in the SquirrelView Desktop Software Device tree.

5.3.2 Connecting sq 16 and sq 16 plus loggers to your sq hub

Up to two sq16 loggers can be connected directly to the Logger USB ports on the sqhub.

More loggers can be connected to the sqhub utilising an external standard USB2.0 hub. A powered hub is required if the loggers are being powered by USB

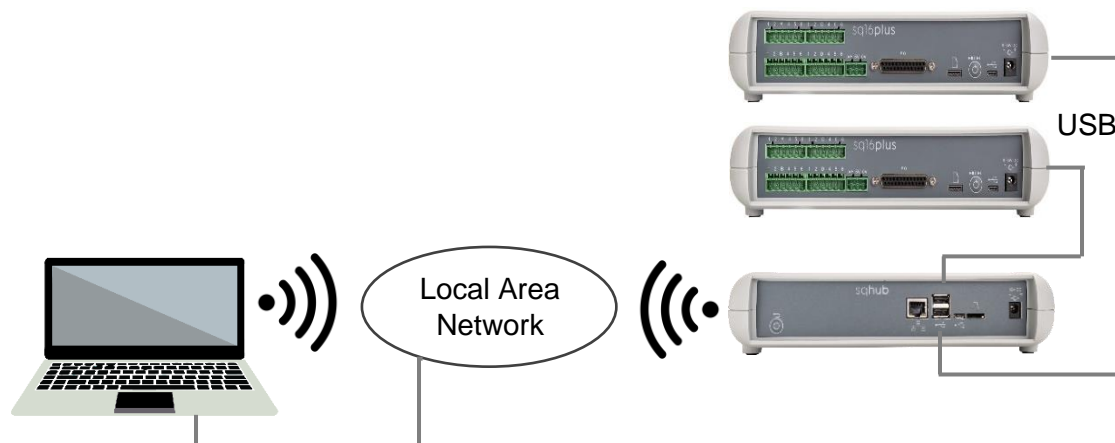

Your sqhub will now be available in the SquirrelView Desktop Software Device tree.



Start SquirrelView Desktop.

Your sqhub can be identified the Device tree by its Serial number. In this example KW2228007

Click on the Plug icon of the sqhub  to connect and view the loggers attached to the sqhub.



The Plug icon will change to Connected  and the loggers will appear in the Device Tree with the logger serial number followed by the logger model type sq16 or sq16plus. In this example KY2221002 sq16plus.

The loggers can then be selected and configured in the same way as loggers connected directly to a PC

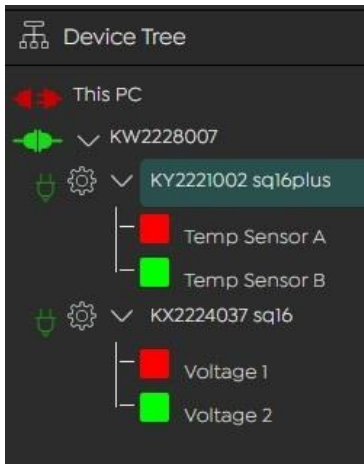

Click on the Logger Settings icon  to configure your logger with sensor inputs and other logging configuration details.

Once configured, click on the logger's name in the Device Tree to select and enable logging and metering of sensor data.

For further information and product details please refer to "34707 Logger Operating Manual" available to download from our website at:

<https://grantinstruments.com/data-acquisition/squirrel-loggers/sq-series-overview>

Also available on individual Squirrel product web pages

6.0 Technical specifications

6.1 Input ranges sq16

		Inputs	
		sq16	sq16plus
Resistance	2 wire	0 to 300,000R	0 to 300,000R
	3 wire	-	0 to 10000R
	4 wire	-	0 to 10000R
Voltage (Single ended and Diff)			
		-1.5 to 2.5V	-0.3 to 0.3V
		-25 to 50V	-1.5 to 2.5V
			-6 to 10V
			-40 to 60V
Current			
		4 to 20mA	4 to 20mA
		-30 to 30mA	-30 to 30mA
Thermistor			
U		-50°C to +150°C	-50°C to +150°C
UU		-50°C to +150°C	-50°C to +150°C
Y		-50°C to +150°C	-50°C to +150°C
S		-30°C to +150°C	-30°C to +150°C
User		-50°C to +150°C	-50°C to +150°C
Thermocouple			
B		250°C to +1820°C	250°C to +1820°C
C		0°C to +2320°C	0°C to +2320°C
D		0°C to +2320°C	0°C to +2320°C
J		-200°C to +1200°C	-200°C to +1200°C
K		-200°C to +1372°C	-200°C to +1372°C
N		-200°C to +1300°C	-200°C to +1300°C
R		-50°C to +1768°C	-50°C to +1768°C
S		-50°C to +1768°C	-50°C to +1768°C
T		-200°C to +400°C	-200°C to +400°C
Pt 100			
2 wire IEC751		-200°C to +850°C	-200°C to +850°C
2 wire JIS1604		-200°C to +850°C	-200°C to +850°C
3 wire IEC751		-	-200°C to +850°C
3 wire JIS1604		-	-200°C to +850°C
4 wire IEC751		-	-200°C to +850°C
4 wire JIS1604		-	-200°C to +850°C
Pt 1000			
2 wire IEC751		-200°C to +850°C	-200°C to +850°C
3 wire IEC751		-	-200°C to +850°C
4 wire IEC751		-	-200°C to +850°C

6.2 General specification sq16

ANALOG INPUTS

Basic accuracy (5-45°C):± (0.05% readings + 0.025% range)
Common mode rejection:96dB
Maximum permissible common mode voltage to supply 0V.....+/-60Vdc
Maximum permissible voltage between pins.....75Vdc (sq16)
Maximum permissible voltage between pins.....100Vdc (sq16plus)
Input impedance:> 1MOHM
Linearity:0.0015%
Series mode line rejection:.....50/60Hz 100dB
EM field and Conducted RF effect:< 1%

DIGITAL INPUTS

Zero input voltage.....0 to 0.5V (or shorted input)
One input voltage.....2.7 to 5V (or open circuit input)
Input protection.....will turn on below about -0.5V and above about 6V

ANALOG-DIGITAL CONVERSION

Type:Sigma-Delta
Resolution:32bit
Sampling rate:Up to 16/100 readings per second

ALARM OUTPUTS.....4 x open drain FET (36V 0.1A Max)

SENSOR POWER SUPPLY.....Regulated 5 VDC (50mA) or supply voltage (100mA)

TIME AND DATE.....In built clock

SCALING DATA.....Displays readings in preferred engineering units

MEMORY

Internal:16Gb (Up to 250 000 000 readings)
External:16Gb removable MMC/SD memory card

RESOLUTION.....Up to 6 significant digits

PROGRAMMING/LOGGER SET-UP.....SquirrelView software or SquirrelView App

COMMUNICATION.....USB, Bluetooth

POWER SUPPLY

Internal:6* AA Alkaline batteries
External:9-36VDC, input is reverse polarity and over-voltage protected

POWER CONSUMPTION @ 9V

Absolute maximum.....1.1A
Sleep mode:<600µA
Logging:40 - 120mA

DIMENSIONS AND WEIGHT

Dimensions:W235 x D175 x H55 mm
Weight:Approx 1.2kgs
Enclosure material:ABS

MEMORY MODES (internal only).....Stop when full or overwrite

OPERATING ENVIRONMENT

Temperature.....-30°C to +60°C
Altitude above sea level.....Up to 2,000m (6,500ft)
Maximum relative humidity.....80% RH up to 31°C

* Maximum operating temperature for supplied alkaline batteries is 50°C

6.3 General specification sq hub

1. Communications	
Local Area Network	Gigabit Ethernet 802.3z RJ45 port Wi-Fi 802.11b 2.4 GHz OpenThread mesh network 802.15 (Optional)
Wide Area Network	LoraWan (Optional) 4G/LTE (Optional)
Link to sq16 Data Loggers	2 x USB2 Type B ports
Local hub comms	Micro USB2 port
2. Power	
MPU18V Mains power adapter (100-240V AC input) 18V DC output.	18V DC external power input jack socket
3. Physical properties	
Dimensions:	W235 x D175 x H55 mm
Weight:	1.2kgs
Operating (ambient) temperature limits:	+10°C to +45°C
Storage (ambient) temperature limits:	-20°C to +45°C
Altitude above sea level:	Up to 2,000m (6,500ft)
Maximum relative humidity:	80% RH up to 31°C

7.0 Warranty Information

When used in laboratory conditions according to this manual, this product is guaranteed for THREE YEARS against faulty materials or workmanship.

Extended warranty for year five can be purchased by contacting our sales department at salesdesk@grantinstruments.com.

8.0 Maintenance and service

8.1 Cleaning

Clean the outside of the equipment with a soft damp cloth, using water only. Do not use chemical cleaning agents. Before using any other cleaning or decontamination method, check with Grant Instruments or your local representative to make sure that the proposed method will not damage the equipment.

8.2 Replacing the mains PSU

This equipment must only be used with an appropriately approved mains PSU acceptable for the country in which the equipment is intended to be used.

The mains PSU must be suitably rated for the logger it is intended to be used with, refer to section 5.2 of this manual for further details.

No user replaceable parts, if the PSU is damaged do not use it, disconnect it from the supply immediately and contact Grant Instruments or your authorised service agent for replacement. You can continue to use the logger on battery power or using a suitably rated mains PSU (see section 5.2 of this manual for further information).

8.3 Support and Service

Contact Grant Instruments or your local representative for support, Service and calibration services.

Grant Instruments (Cambridge) Ltd

Shepreth
Cambridgeshire
SG8 6GB
UK

Tel: +44 (0) 1763 260811
support@grantinstruments.com
www.grantinstruments.com

9.0 Optional Accessories

Accessory	Stock Code
Calibration Certificates for Squirrel SQ16 series. Note: Test and Calibration Certificates from Grant Instruments are traceable to National Standards	
Calibration Certificate for SQ16 data logger	CALSQ16
Calibration Certificate for SQ16PLUS and SQ16PRO data logger	CALSQ16P
Wall Bracket	
Secure Mounting Cradle for SQ16 loggers and SQHUB	SQ CRADLE
Power Supplies	
100-240V AC 50/60Hz supplied with 3-single fit mains plugs for UK, Euro, & US. 12V DC output for sq 16 * sq16 plus	MPU 12V
As MPU 12V but supplied with 1m flying lead	MPU 12VFL
100-240V AC 50/60Hz supplied with 3-single fit mains plugs for UK, Euro, & US. 18V DC output for sqhub	MPU 18V
Digital I/O interface connector	
25 way D connector type sub miniature solder connection with cover for digital inputs, alarm and pulse inputs	SB102
Current Shunts	
Pack of 4 precision resistors for 4-20mA analogue channels	CS202
Cables for connecting SQ16 loggers to computers	
USB cable A Plug to micro B Plug 1.5m	34379
Terminal Blocks	
3-way Plug in terminal block with cable restraint for sensor power supply	14174
6-way Plug in terminal block with cable restraint for sensor/probe inputs	18097
Temperature and Humidity probes	
Grant Instruments offers a range of temperature and humidity probes suitable for use with its data loggers and other compatible measurement systems. Bespoke or specialist probes are also available. Please enquire if you have specialist probe needs	
Communications Gateway	
SQHUB networking gateway for operating multiple loggers and enabling WiFi and Ethernet connection with optional 4G	SQ HUB

10.0 Troubleshooting

Please visit our online support pages, these include latest Firmware and Software updates at: <https://grantinstruments.com/support/support>

11.0 Compliance

Waste Electrical and Electronic Equipment (WEEE)



This product marked with the crossed-out wheellie bin symbol indicating it must not be disposed of with unsorted waste. Safe recycling of WEEE helps conserve natural resources and protect human health.

Grant Instruments complies fully with the UK Waste Electrical & Electronic Equipment (WEEE) regulations 2013. We are a member of the B2B compliance scheme (Scheme Approval Number WEE/MP3338PT/SCH), which handle our WEEE obligations on our behalf. Grant Instruments have been issued with a unique registration number by the Environmental Agency, this reference number is WEE/GA0048TZ.

For information regarding WEEE collections in the UK please contact our B2B Compliance Scheme directly on 01691 676 124 or www.b2bcompliance.org.uk

In the EU, Grant Instruments complies with WEEE Directive 2012/19/EU. Contact your local equipment supplier for WEEE collections.

Restriction of substances hazardous to health (RoHS)

This product complies with the requirements of the UK Restriction of the Use of Certain Substances in Electrical and Electronic equipment Regulations 2012 and the EU RoHS Directive (2011/65/EC including 2015/863). This means the products are free of Lead and other hazardous substances covered by the directive.

Electrical safety and electromagnetic compatibility

This product complies with the requirements of the UK Radio Equipment Regulations 2017 and the European Union Radio Equipment Directive 2014/53/EU for radio function and electrical safety.

This product complies with the requirements of the UK Electromagnetic Compatibility Regulations 2016 and the European Union EMC directive (2014/30/EC).

Compliance in the USA

This device complies with part 15 of the FCC Rules. Operation is subject to the following two conditions: (1) This device may not cause harmful interference, and (2) this device must accept any interference received, including interference that may cause undesired operation

Responsible party:

Grant USA Inc
2750 Constitution Blvd
Suite 7
Beaver Falls PA 15010
Tel. 425-363-2352

REACH Regulation

This product does not contain any Substances of Very High Concern (SVHCs) at greater than 0.1% that have to be identified in accordance with Regulation (EC) No 1907/2006 and therefore does not have an entry in the SCIP database.



Grant Instruments (Cambridge) Ltd
Shepreth
Cambridgeshire
SG8 6GB
UK

Tel: +44 (0) 1763 260811
salesdesk@grantinstruments.com
www.grantinstruments.com

Grant Instruments Europe B.V.
Strawinskylaan 411
WTC, Tower A, 4th Floor
1077 XX, AMSTERDAM
THE NETHERLANDS

grant@eu.grantinstruments.com

34707 V4 DMN V75 March 2023